

Sicheres Fassadengerüst

Helfen Sie mit, Unfälle zu vermeiden!

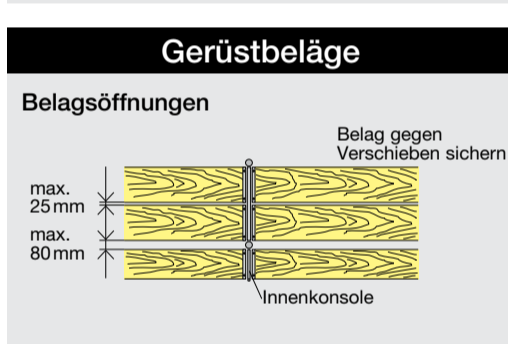
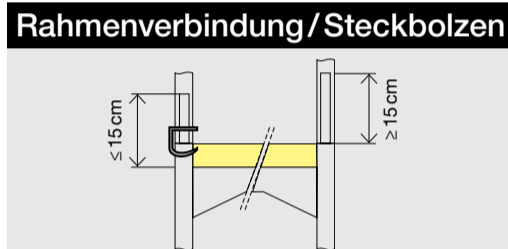
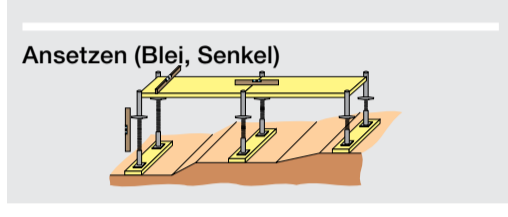
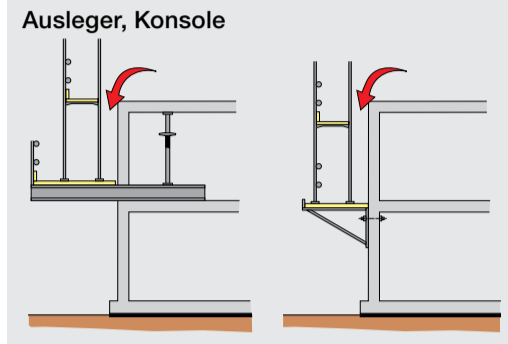
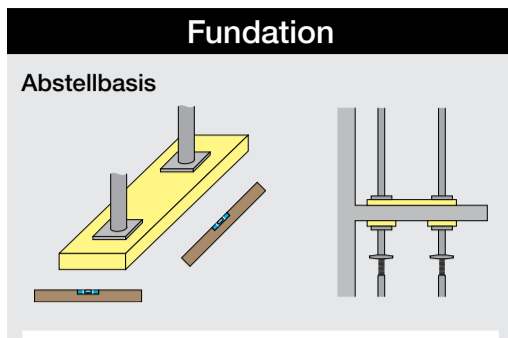
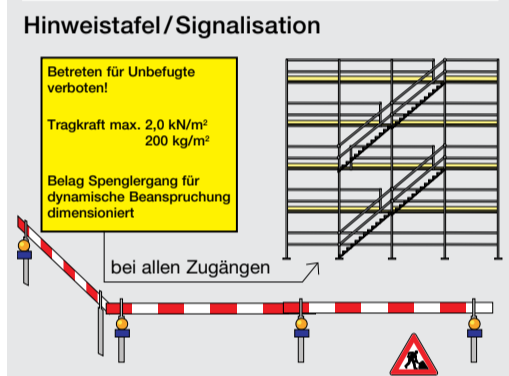
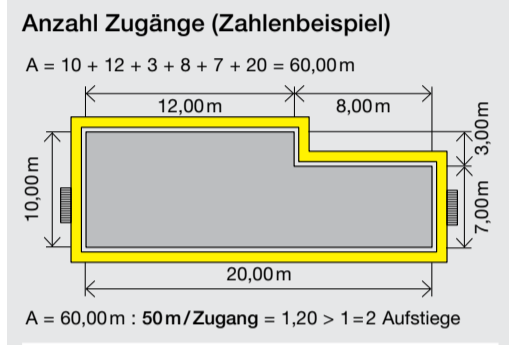
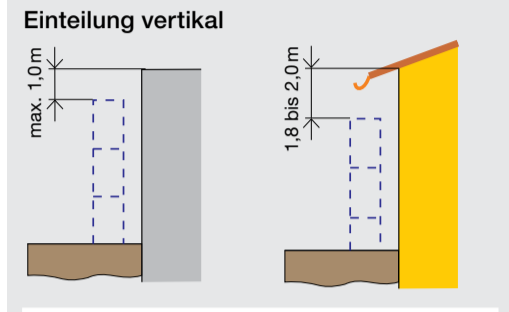
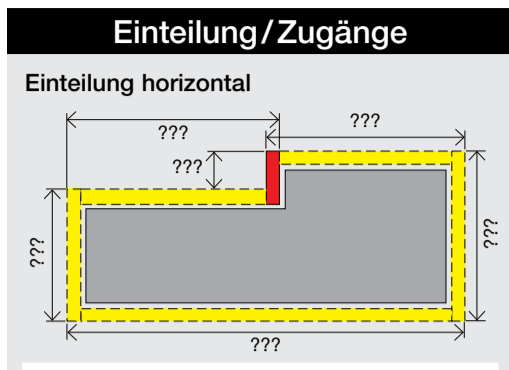
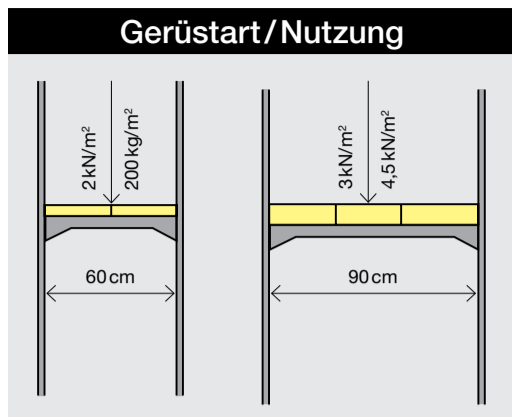

Spannweiten von Gerüstbrettern

Brettstärke	maximale Spannweite	
Gerüstbretter	2 kN/m² / 200 kg/m²	3 kN/m² / 300 kg/m²
40 mm	2,25 m	2,00 m
45 mm	2,50 m	2,25 m
50 mm	3,00 m	2,50 m

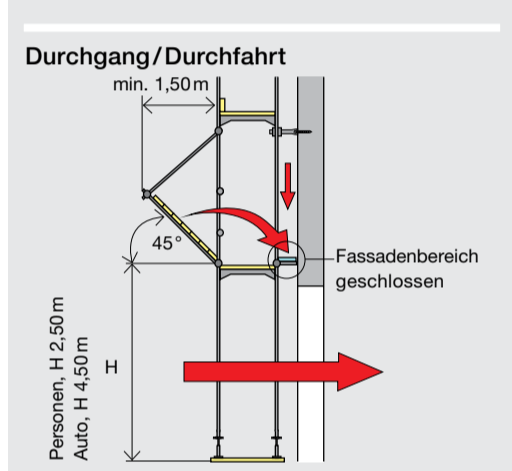
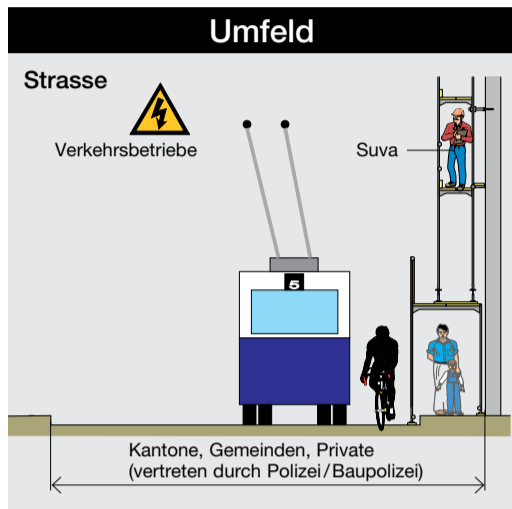
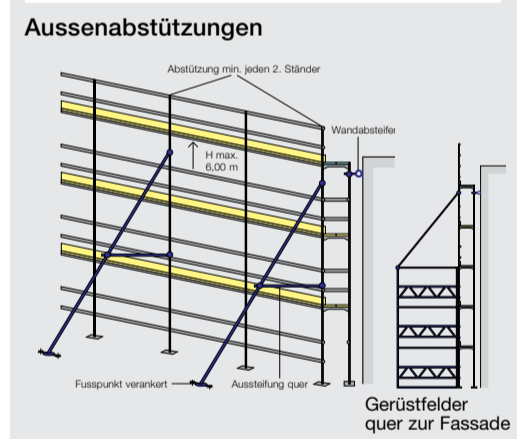
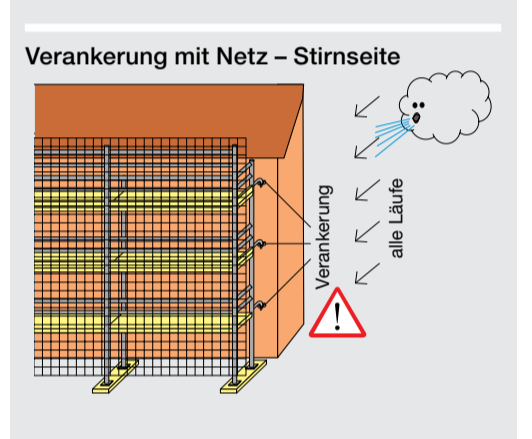
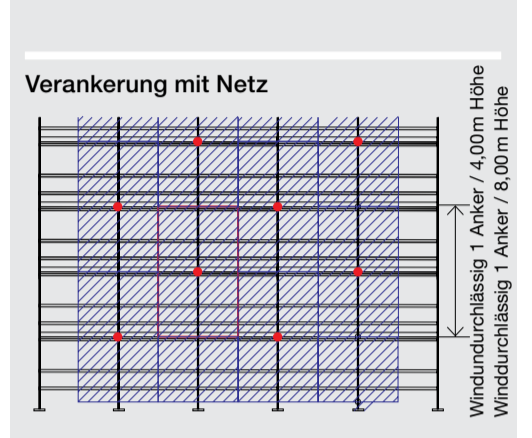
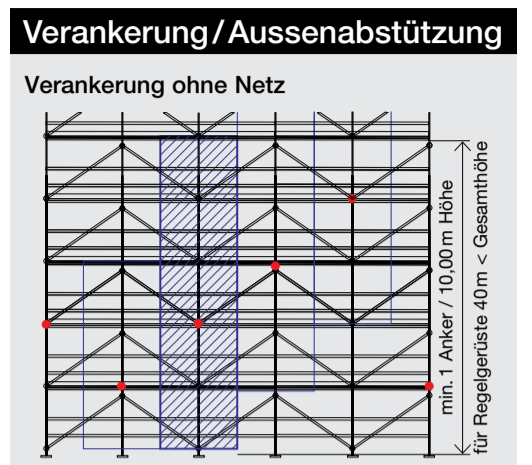

Gerüst an Dachrand

